

Electronics Cooling Terms and Key Principles

AC Voltage – “AC” is the abbreviation for “Alternating Current” voltage. It’s the type of electricity provided by utility companies to residential homes and commercial businesses. AC voltage gets its name as “alternating current” because the electricity reverses direction or cycles many times per second as shown in the diagram below.

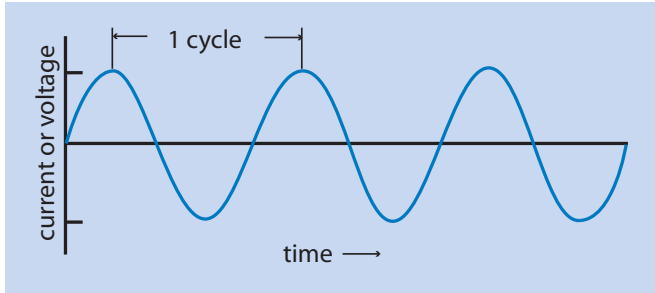

AC electricity in North America is supplied at 60 cycles per second or “60 hertz (Hz).” In Europe and many other parts of the world, 50 Hz is standard. Common voltages supplied with AC current are 115V (in residential homes), 230V and 460V (for industrial applications).

AC electricity contrasts with DC voltage which is “Direct Current.” DC electricity gets its name because it is unidirectional and does not cycle, thus there are no hertz (Hz) with DC voltage. Common DC voltages include 12V, 24V and 48V.

115V AC voltage is typically “single-phase” as shown in the diagram above. 460 AC voltage supplied to industry is “3-phase” which means there are 3 waves (“pulses”) in the current rather than 1. The 3 waves operate out-of-sync with each for a more even, continuous flow of electricity to the factory equipment. Thus, AC electric motors and other equipment receiving 460 AC 3-phase voltage operate smoother and with less vibration. 3-phase motors and generators are also more economical than their single-phase counterparts.

Why You Need to Know This – *When specifying an air conditioner, heat exchanger or air mover, it is important to determine the type of electricity available at the electrical enclosure such as AC or DC and its voltage level, so that the cooling product can be manufactured to properly match the electrical supply.*

Air Conditioner – Air conditioners are used for electronics cooling when engineers need to accomplish the following with their enclosure or cabinet system:

1. *The sensitive electronics inside the cabinet needs to be isolated and sealed away from conditions outside the enclosure such as dirty, dusty, corrosive air or wind-driven rain (known as “closed loop” cooling).*
2. *The maximum temperature of the electronics must be cooler than the maximum potential air temperature outside the cabinet.*
3. *The electronics need to be protected against the harmful affects of humidity.*

How Air Conditioners Work - While air conditioners feel like they produce cold air, they actually work by pulling in the hot air from the electrical cabinet and transferring the heat energy away from the enclosure itself. The air flowing into the enclosure has the heat energy removed and thus feels colder.

Electronics cooling air conditioners have 2 basic systems at work within them. The first is the compressor, refrigerant, evaporator coil and condenser coil system which transfers the heat energy from inside the electrical cabinet to outside the enclosure. The second is the air mover system which is comprised of cabinet-side and exterior-side blowers. The cabinet-side blower circulates the hot enclosure air over the evaporator coil, so that the refrigerant picks up the heat energy to move it to the exterior-side of the air conditioner. The exterior-side blower then exhausts the heat energy away from the condenser coil to the outside of the air conditioner. (See side-view diagram below).

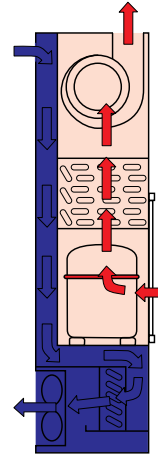

As in building cooling, a thermostat monitors the temperature inside the enclosure and tells the air conditioner when to begin removing heat from the cabinet to cool the vital electronics. Typically the thermostat is set at 75°F / 24°C, the coolest temperature usually desired in an electrical enclosure. Thermostats often have a differential setting of 10°F / 6°C. Thus, the temperature inside the cabinet is allowed to increase to 85°F / 29°C before the air conditioner begins to run to reduce the temperature back to 75°F / 24°C. At this point, the air conditioner turns off until the cabinet temperature increases again to the differential setting of 85°F / 29°C.

While the compressor and exterior-side condenser blower only run when cooling is required, the cabinet-side evaporator blower operates continuously for the life of the air conditioner to ensure more effective cooling of the sensitive electronics.

Unlike building cooling, electronics cooling is not designed for human comfort. For example, the differential setting has a broader range of 10°F / 6°C. Additionally, the evaporator coil and blower are separate from the condenser coil, compressor and condenser blower whereas in electronics cooling, they are packaged all together in one air conditioner unit. Finally, the thermostat is typically not set any lower than 75°F / 24°C in electronics cooling to reduce the possibility of condensation forming on the vital electronics, thus minimizing the potential for corrosion and electrical shock.

Why You Need to Know This – When specifying an air conditioner, it is important to determine its cooling level (capacity) as well as thermostat and differential settings to ensure an optimum amount of cooling for the sensitive electronics. Gathering vital information such as maximum temperature allowed by the electronics manufacturer and maximum potential temperature outside the enclosure will help you determine cooling capacity and proper thermostat settings. (See “Cooling Capacity” for further information). Your electronics cooling manufacturer can also help you determine cooling capacity and other air conditioner features.

Ambient / Ambient Temperature– Ambient refers to the environment or conditions surrounding the electrical cabinet whether it is located outdoors or indoors. Most electronics cooling air conditioners are designed to operate in 50°F to 131°F / 10°C to 55°C ambient air temperatures. If the air conditioner needs to operate in lower temperatures, many electronics cooling manufacturers provide low-ambient temperature kits.

Why You Need to Know This – Understanding the ambient conditions of the electrical enclosure is critical to the proper specification of an electronics cooling solution.

- *Is the ambient environment an air-conditioned factory? If yes, this may lead an engineer to select a heat exchanger vs. an air conditioner.*
- *Will the enclosure potentially be located outdoors near the ocean, in the desert or in a tropical region? If yes, one may need the cooling solution to stand up to corrosive salt air or perform in high outdoor temperatures.*
- *Could the application be located at high altitudes? If yes, maximum operating ambient temperature for an air conditioner may be affected, depending on the altitude (consult your manufacturer).*
- *Will the electronics cabinet be placed in dusty industrial conditions such as a paper mill or tobacco factory? If yes, special filters or a filter-less option may be needed to prevent the condenser coils from clogging.*
- *Will the cooling solution be located near a blast furnace or other high-temperature equipment? If yes, adequate protection and cooling capacity will be required for these extreme ambient conditions.*

As you can see, ambient temperatures and conditions can vary widely. So be sure to communicate them to your electronics cooling supplier.

Amps / Amperes / Amperage – It is the unit for measuring electric current or flow rate. An amp represents the quantity of electrons flowing past a given point in one second through a conductor such as a wire. It is analogous to cubic feet of water flowing per second. The flow rate of electrical current is calculated as follows:

$$\text{Amps (Current)} = \frac{\text{Watts (Power)}}{\text{Voltage (Pressure)}}$$

One ampere is the electrical current flowing through one ohm of resistance at one volt potential.

Why You Need to Know This – When specifying an air conditioner, heat exchanger or air mover, it is important to determine the amperage of the electrical supply, so that the proper cooling product can be specified to work with it. Manufacturers will then supply the appropriate wiring and circuit protection to the unit.

ANSI Color System – A standardized color system from the American National Standards Institute for the consistent application of colors across components and products. For example, ANSI 61 gray is a popular powder-coat paint color used in the electrical enclosure industry.

Why You Need to Know This – When specifying electronics cooling products, it is important to determine the standard color of the product supplied by the manufacturer or, if desired, request that it matches the color of the electrical cabinet. The ANSI color system is an easy way to communicate color expectations because it employs a standardized set of numbers which many electrical enclosure and cooling manufacturers use.

Blower – This is a type of air mover often used in air-cooling systems which have medium to high static pressures. Single blowers typically move as little as 75 CFM (cubic feet per minute) or 128 M³/HR (cubic meter per hour) of air. Dual-blowers can move as much as 825 CFM or 1,403 M³/HR.

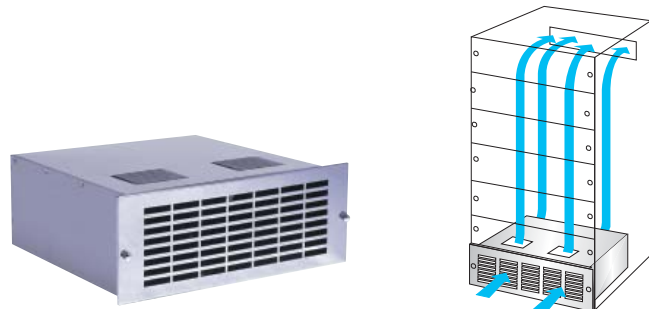

Blowers are more effective than fans at pushing or pulling air through systems that have restricted air flow. They can operate with variable speed (usually powered by DC voltage) to conserve energy, reduce the rate of filter contamination and extend blower life. AC-powered blowers are also available. Blowers are used in air conditioners, heat exchangers and even on their own within electronics enclosures.

Why You Need to Know This – When specifying a blower for fresh-air (open-loop) cooling or replacing a blower in an air conditioner or heat exchanger, it is especially important to know the amount of air movement required—CFM or M³/HR—and type of power supply—DC or AC.

BTU/Hr (British Thermal Unit per Hour) – It’s a common term used in the U.S. heating and cooling industries. A BTU is technically defined as the amount of heat energy needed to raise the temperature of one pound of water by one degree Fahrenheit in one hour. Put in simpler to understand terms, one BTU is approximately equal to the heat produced by a wooden kitchen match. “Watts” are typically used to define the amount of heat energy in all other parts of the world. To convert from BTU/Hr to Watts, multiply the BTU/Hr X 3.412128. (See “Watts” for more details).

Why You Need to Know This – Cooling capacities in the United States are expressed as BTUs/Hr and are important to know for specifying air conditioners and heat exchangers.



CE – CE is the abbreviation for Conformité Européenne, French for European Conformity. It is required for products sold in the European Economic Area (EEA), including electronics cooling solutions, which indicate the product meets certain health and safety directives. Companies may use external test facilities to certify that their product meets CE requirements, or they may internally document the standards that the product conforms to, before using the CE mark in promoting their product.

Why You Need to Know This – In specifying electronics cooling solutions for use in the European Economic Area (EEA), it is important to choose an air conditioner, heat exchanger, fan, blower or impeller that conforms with CE directives for health and safety.

CFD (Computational Fluid Dynamics) – CFD is a software package that visually models air flow and temperature within electronics enclosures and data networking centers. It portrays the “hot” and “cold” spots within these environments by displaying red, orange, yellow, green and blue colors on the computer monitor. The software is used to determine the most effective cooling solution and its placement within the electronics or computing environment.



Why You Need to Know This – When working with complex electronics enclosures or data networking cabinets, CFD “test-drive” the cooling solution prior to specification to ensure optimal performance of the electronics or servers after installation.

CFM (Cubic Feet per Minute) – The rate of air flow through a system or space. CFM is part of the English system of measurement. Under the Metric system, air flow rates are expressed as M³/HR (cubic meters per hour). Air movers such as fans, blowers and impellers are rated at different levels of CFM or M³/HR ability. To convert from CFM to M³/HR, divide CFM by .589.

Why You Need to Know This – In working with air movers, it is important to know if CFM or M³/HR is being used because the specifications are completely different.

Cooling Capacity – In the electronics cooling industry, cooling capacity is the maximum amount of heat energy that an air conditioner or heat exchanger is able to remove. Cooling capacities are expressed as BTUs per hour in the United States or Watts per hour elsewhere in the world. To convert BTUs/Hr to Watts, divide by 3.413. For example, 1,000 BTUs/Hr = 293 Watts. Conversely, to convert Watts to BTUs/Hr, multiply by 3.413.

Typical air conditioner cooling capacities range from 1,000 BTUs per hour / 294 Watts per hour (small capacity) to 20,000 BTUs per hour / 5,882 Watts (large capacity). Some air conditioners installed on outdoor telecom shelters provide as much as 60,000 BTUs per hour / 17,647 Watts in cooling capacity! 12,000 BTUs/Hr = 1 “ton.” Thus, 60,000 BTUs/Hr = 5 tons.

Heat exchangers also remove ranges of heat energy, but use a different system to describe their cooling capacity which is Watts per °F or °K (Kelvin). Common heat exchanger cooling capacities range from 4 to 84 Watts / °F or 7 to 151 Watts / °K. (See “Heat Exchangers” for a more thorough explanation of when to use them and how they work).

Why You Need to Know This – Understanding the amount of heat energy or BTUs produced by the electronics inside the electrical enclosure is critical to specifying the right air conditioner or heat exchanger capacity. Does the engineer need to remove a low, medium or high amount of BTUs or Watts from the electronics system?

To determine the amount of BTUs or Watts to cool, add together the Watts of electricity consumed by the electronics system, then multiply the total by the efficiency of the system. The remaining amount of Watts left over becomes the approximate level of cooling capacity needed for the electronics system. Here’s an example—

Total Watts of the Electronics System:	20,000
Efficiency of the System:	93%
Proportion of Watts Un-Used:	7%
Watts Un-Used by the System:	1,400
BTUs/Hr Un-Used by the System (x 3.413)	4,782

Thus, for the above electronics system, approximately 1,400 Watts or 4,782 BTUs per hour of cooling capacity are needed. Other factors such as solar heat gain, maximum temperature allowed by the electronics manufacturer and maximum ambient temperature are also important considerations in selecting an air conditioner or heat exchanger and finalizing its cooling capacity.

Chilled Water Cooling - Instead of refrigerant and a compressor, chilled water is circulated through the computer server cabinet by a chiller to take away the heat energy from the enclosure. The chilled water moves through a coil or heat exchanger within the cabinet; fans blow the hot air over the coils to remove the heat energy from IT cabinet.

Why You Need to Know This – Chilled water cooling is often used when (a) large amounts of heat such as 20,000 BTUs are needed to be removed from the enclosure and (b) circulating or chilled water is nearby the enclosure. Typical applications which use chilled water cooling include mid- to large-size IT network cabinets or large industrial enclosures in high-temperature environments.

Closed-Loop Cooling – This is a type of cooling which removes heat from an electrical enclosure while enabling the cabinet to remain sealed, protecting the sensitive electronics from the hostile environment outside the cabinet. In certain applications, the air surrounding the electronics cabinet can contain dirt, dust, high-pressure water from wash-down hoses, fine metal grindings, oil, corrosive fumes, ocean air, humidity, wind-driven rain and/or extremely high temperatures which can damage the vital electronics. A closed-loop cooling solution such as an air conditioner or heat exchanger takes away heat while preventing these hazardous elements from entering the electrical enclosure and coming in contact with the sensitive electronics. Closed-loop cooling systems are also used when ambient-air or “open-loop” cooling does not provide enough cooling capability to control the temperature of the electronics system (see “Open-Loop” for additional details).

Why You Need to Know This – Be conscious of the potential environment where the electrical enclosure could be installed. If there's any possibility of the ambient air entering the cabinet and the damaging vital electronics through contaminants and/or high temperatures, a closed-loop cooling solution such as an air conditioner or heat exchanger should be used.

Coil – An air conditioner component designed to transfer heat, usually made of aluminum fins and copper tubing. On evaporator enclosure-side coils, the hot cabinet air is moved through the coil's aluminum fins to capture the heat energy which is moved away by the refrigerant. On condenser ambient-side coils, air is blown through the coil to absorb the heat dispersed by the aluminum fins. Larger coils have greater ability to transfer heat because the surface area of the aluminum fins is larger.



Why You Need to Know This – Coils are a key component of an air conditioner. On a rare occasion they need replacement. It is important to know the term and if the evaporator or condenser coil is being replaced.

Compressor – Compressors are the "heart" of all air conditioner systems that use refrigerant. The compressor is basically a motor and pump combined in one unit designed to circulate the refrigerant between the evaporator and condenser coils.



There are three basic types of compressors used in air conditioners that provide 1000 to 60000 BTUs/Hr (293 to 17580 Watts) of cooling capacity. One is called a "scroll" compressor which works using a circular motion. The second is called a "reciprocating" compressor which functions in an up-and-down piston action. The third is a "rotary" compressor; the name is self-explanatory.

Why You Need to Know This – Compressors are also a key component of an air conditioner which need occasional service. It is useful to know the term, so that one has an understanding of the part that is being repaired or replaced.

Condensation / Condensate – In electronics cooling, condensation or condensate is water droplets that appear on surfaces such as the air conditioner evaporator coil or other parts inside the enclosure. Condensation forms when warm humid air comes into contact with cooler surfaces or air flow. If not effectively managed, condensation can damage the vital electronics inside the cabinet.

One goal of electronics cooling is to control condensation. Usually this is done with a tray at the bottom of the air conditioner which collects the moisture and allows it to evaporate. Other condensation management systems involve a tube which allows the moisture to simply drain out of the air conditioner. If there is the potential for a lot of condensation to be produced, a small heater can be added to the condensate collection tray to speed the evaporation process.

Why You Need to Know This – A situation which causes excessive and unnecessary condensation is when the door of the electronics enclosure is opened, and the air conditioner is allowed to continue running. Humid air then rushes into the cabinet and thus increases the formation of condensation. The obvious solution to keep damaging condensation at bay is to turn off the air conditioner BEFORE opening the electrical cabinet door. Another option is to design and install an air conditioner shut-off switch at the electrical cabinet door, so that this situation is avoided all together.

Condenser Coil – A key component in air conditioners, the condenser coil is located on the outer "ambient" half of the air conditioner. It is made of a collection of thin aluminum fins through which the refrigerant containing the heat energy from inside the enclosure is circulated. The ambient air is then blown or pulled through the condenser coil to sweep away the heat energy to outside of the air conditioner. Condenser coils get their name because the refrigerant at this point in the air conditioner system converts from gas to liquid, a process known as "condensing."

Why You Need to Know This – Condenser coils are an important element of an air conditioner system. On a rare occasion they need replacement. It is important to know the term and if the condenser coil (exterior-side) or evaporator coil (cabinet-side) of the air conditioner is being replaced.

Core – The central component of an electronics cooling heat exchanger, the core is comprised of long, thin aluminum sheeting that is folded and assembled into an accordion shape. The hot cabinet air is circulated through one side of the core; the cooler ambient air is circulated through the other side of the core. In this process, the heat energy is transferred across the metal in the aluminum core, and is then swept by the ambient blower.

Why You Need to Know This – Heat exchanger cores cool electronics only when the maximum electronics enclosure temperature is allowed to operate ABOVE the ambient temperature outside the cabinet. This is an essential electronics cooling principle when selecting a heat exchanger.

Corrosive Environment / Atmosphere – Frequently, air conditioners and heat exchangers are used to cool the sensitive electronics found in corrosive environments which could include a chemical factory, water treatment plant, petro-chemical production facility and salty ocean air. If exposed to these atmospheres, the vital electronics would quickly corrode and malfunction. Thus, the electrical enclosure and air conditioner or heat exchanger need to hermetically seal out the corrosive air to protect the electronics.

Why You Need to Know This – Because corrosive air cannot be used to cool vital electronics, fan or "open loop" cooling is not a viable option to remove the heat energy from the electrical enclosure. Instead, air conditioners and heat exchangers with added protection for corrosive environments are the only viable electronics cooling solutions for these applications.

CUL / ULC – Since the Canadian and U.S Underwriters Laboratories closely work together, please see the definition for “UL.”

Cut-Out / Cut-Out Pattern – A cut-out refers to the two holes in the electrical cabinet and back of the air conditioner or heat exchanger through which the enclosure-side air flows.

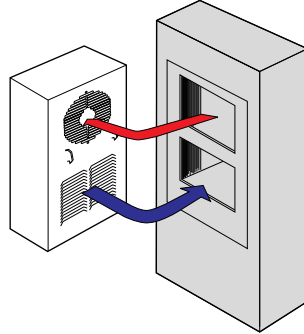
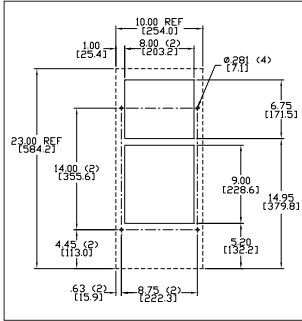

Why You Need to Know This – It is critical that the cut-out patterns of the electrical enclosure and air conditioner or heat exchanger match. Otherwise, the cabinet-side air will not properly flow through the cooling product or, worse yet, create a hole to the outside air. A gland plate and plenum are typical solutions when the cut-out pattern on the enclosure does not match with the cut-out pattern of the air conditioner or heat exchanger. (See “Gland Plate” and “Plenum” for additional details).

Damper – A motorized metal flap used in certain electronics cooling air conditioners as part of an “economize” package. When the ambient air is cool enough, the damper opens to bring in the cool air and remove the heat energy inside the enclosure. When the ambient air becomes warm, the damper closes and the air conditioner compressor / refrigerant system removes the heat energy. Because the compressor runs less often, less electricity is used and less noise is produced. (See “economizer” for more details).

Why You Need to Know This – Only under certain conditions can damper cooling on an air conditioner be used: (a) the ambient temperature is often low enough to use fresh-air cooling and (b) the ambient air is not corrosive and can be filtered before reaching the vital electronics.

DC Voltage - The term means “Direct Current.” Unlike AC (Alternating Current) voltage which changes polarity 50 – 60 times per second, DC voltage always remains unidirectional and does not cycle. A good example of a DC current is the electricity supplied by household and car batteries. Small household batteries such as AAA, AA, C or D provide about 1.5 volts of DC power. Other common DC voltages include 12 V, 24 V and 48 V. Outdoor telecom systems often have a collection of DC batteries similar to car batteries to provide back-up power in case the AC power supply to the cell tower is interrupted.

Why You Need to Know This – When specifying an air conditioner, heat exchanger or air mover, it is important to determine the type of electricity available at the electrical enclosure such as DC or AC and its voltage level, so that the cooling product can be manufactured to properly match the electrical supply.

Delta-T (ΔT) – Delta-T is the difference between the interior enclosure temperature and the ambient temperature outside the cabinet. Engineers need to know maximum potential enclosure and ambient temperatures, because this will drive the level of cooling capacity required of the air conditioner or heat exchanger. The difference between the two maximum temperatures is referred to as the “Delta-T.”

Why You Need to Know This – It’s a useful term when specifying an electronics cooling air conditioner or heat exchanger. A large vs. small Delta-T can affect the amount of cooling capacity required for the electronics system. (See “De-Rate” and its Cooling Capacity Illustration for more details).

De-Rate / De-Rating – It is the cooling capability of a specific air conditioner or heat exchanger at different ambient and enclosure temperatures.

Ambient temperature can significantly affect the level of required air conditioner or heat exchanger cooling capacity. For example, an air conditioner operating in high ambient temperatures such as 131°F / 55°C (in the desert sun or near a blast furnace) provides less cooling capacity because the air conditioner is less able to transfer the enclosure heat energy out through the condenser coil and into the hot outside air. Conversely, an air conditioner operating in low ambient temperatures such as 75°F / 24°C (an air conditioned factory) can provide more cooling capacity because the heat energy more quickly transfers out through the condenser coil and into the cool surrounding air.

Enclosure temperature can also affect the cooling capacity required of an air conditioner or heat exchanger. For example, an air conditioner that may confront a high enclosure temperature of 131°F / 55°C, because a lot of hot electronics is packed into the cabinet, will need to be a larger capacity air conditioner. The reason is that the unit will have a lot of heat energy to take away from the electronics enclosure. Conversely, an air conditioner facing a lower enclosure temperature of 77°F / 35°C can be smaller capacity because there is less heat energy to remove.

An application of high ambient and enclosure temperatures of 131°F / 55°C requires a higher capacity air conditioner or heat exchanger because there is a lot of heat energy at both ends of the electronics cooling system.

The following chart is an example of the cooling capacity of an air conditioner at potential ambient and enclosure temperature levels.

Cooling Capacity of an Air Conditioner

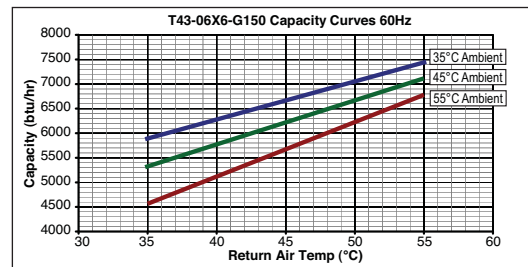

“De-Rate” is the difference between the ambient temperature curves and the slope of each curve. Air conditioners with higher reported ambient temperature curves and flatter slopes are more efficient and effective at removing heat energy (?).

Why You Need to Know This – Looking at a cooling capacity rating curve is essential to selecting an air conditioner. An engineer needs to know the maximum potential ambient and enclosure temperatures in order to specify a unit with the right amount of cooling capacity and prevent the electronics from over-heating.

Additionally, electronics cooling companies present their cooling performance levels in an inconsistent way. There are no industry standards for presenting the information. For example, one company may take a more conservative approach in reporting air conditioner cooling capacity by using higher 55°C ambient / 55°C enclosure as maximum potential temperatures to ensure the customer has sufficient cooling capacity for their electronics system. Others may use more lower temperatures such as 24°C ambient / 35°C enclosure temperatures to promote a higher cooling capacity level and lower price. However, the customer may end up buying an under-performing air conditioner for their application. Thus, one must carefully understand the temperatures and cooling capacities of the air conditioners being evaluated before making a final selection.

EMI (Electromagnetic Interference) - Electrical “noise” that is generated by an electrical product such as an air conditioner or heat exchanger, interfering with the operation of communications equipment such as telecom base station radios.

Why You Need to Know This – If equipment sensitive to EMI is being used in the electronics enclosure, it is important to select an air conditioner, heat exchanger or air mover that keeps the equipment protected from EMI.

Enclosure – The structure in which electrical or electronics equipment is packaged. Enclosures can be small sheet metal cabinets that house manufacturing process control electronics. They can be mid-sized indoor data networking or outdoor telecom cabinets. Enclosures can also be a concrete-block shelter used at the bottom of telecom cell towers to house and protect the base station radio equipment.

Electrical Enclosure



Data Networking.jpg



Telecom Cabinet.jpg



Telecom Shelter.jpg



Metal enclosures used in outdoor applications often contain a layer of insulation on the inside surfaces of the cabinet. The insulation is approximately ½-inch (13 mm) thick and made of foam or bubble-wrap and aluminum foil material. The purpose of the insulation is to minimize extra heat load caused by the sun’s green house affect on the enclosure.

Why You Need to Know This – Enclosure is a common term in the electronics cooling industry. Understanding the size, surrounding conditions and heat energy (watts) produced inside the enclosure drive selection of the proper electronics cooling solution.

Enclosure Temperature – It is the maximum potential temperature that can occur inside electronics cabinet or maximum desired temperature inside the electronics cabinet.

Why You Need to Know This – Enclosure temperature is essential information for specifying the most effective electronics cooling solution such as an air conditioner, heat exchanger or air movers.

Evaporator Coil – A key component in air conditioners, the evaporator coil is located on the inner “enclosure” side of the air conditioner. It is typically made of a collection of thin aluminum fins through which the cooled refrigerant is circulated. The hot enclosure air is blown over the evaporator coil to absorb the heat energy inside the cabinet to move it to the outside of the air conditioner via the compressor.

The evaporator coil feels cold to the touch because the actual temperature of it can be as low as 45°F / 7°C. The air exiting the evaporator side of the air conditioner is cold because the evaporator coil has just done its job in removing the heat energy, transferring it to the refrigerant in the system.

Why You Need to Know This – Evaporator coils are a key element of an air conditioner system. It is important to know the difference between an evaporator coil (enclosure-side) and condenser coil (exterior-side).

Fan / Axial Fan – The appearance of fans used in electronics cooling are somewhat similar to common household fans, except they are smaller. Their shape consists of four blades set at an angle. The four blades rapidly rotate around a motor powered by AC or DC voltage. The blade/motor assembly is then set into a “fan package” consisting of a metal or plastic housing and grille.



Fans are typically used in low static-pressure applications where the air flow is less impeded because fans cannot force air through a high-resistance system as easily as a blower or impeller. Electronics cooling fans usually move from 40 CFM (65M³/HR) to 1,200 CFM (2,150M³/HR) of air. Some fans are used to pull cool air into the enclosure whereas some are used to exhaust the hot air out of the electronics cabinet, depending on the application.

Why You Need to Know This – If the surrounding air is clean and/or the electronics can tolerate a certain amount of dust and heat, fans are a simple and inexpensive way to pull heat from the electrical enclosure.

Fan Tray – An air-moving product that is usually made of at least several fans and looks flat like a tray, hence its name “fan tray.” Fan trays use the ambient air surrounding the enclosure to remove the heat from the electronics inside the enclosure. Fan trays work well in low static-pressure applications and are commonly found in data networking cabinets to cool the computer servers. Thus, they are manufactured in heights of 1-U (1-3/4”) and 2-U’s (3-1/2”), a standardized measurement system used by the IT industry.

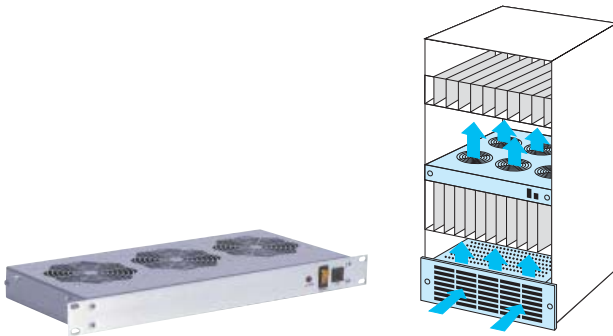

Fan trays typically move air at the rate of 300 CFM (500 M³/HR) to 1,000 CFM (1,700 M³/HR).

***Why You Need to Know This** – In engineering a cooling solution for a data networking cabinet, it is likely that a fan tray may be used. Understanding the sizes and air moving abilities of each model will help one arrive at the most effective solution.*

Filter – Air filters are typically used on air conditioners and open-loop fan systems.

On air conditioners, the filter is located at the ambient air intake of the air conditioner to prevent dirt, dust and other airborne material from clogging the condenser coil, and thus dimensioning the air conditioner’s ability to cool. On open-loop electronics systems, the filter is located at the air intake of the cabinet to screen out contaminants as the fan or blower moves the cool air through the enclosure.

Filters can be an aluminum washable screen that is re-used or a disposable type made of fine interwoven fibers. Technically advanced air filters are also available, so that particles down to 0.1 micron in size, even water itself, can be screened yet air is able to pass through the filter!



Most heat exchangers and some air conditioners on the market today offer filter-less designs to eliminate the need to clean or replace filters.

***Why You Need to Know This** – When designing an electronics cooling system, it is important to know the airborne contaminants and their size if a filter will be used. This will help in selecting the proper filter type because filters can impede air flow to certain degree. Thus, fans or impellers with higher air moving ability are required to ensure enough heat energy is carried away from the electronics enclosure. Additionally, in processing a spare part order for a filter, it is important to know if it is an aluminum washable screen or a disposable type.*

Filter Fan – A type of packaged axial fan with a built-in filter used to draw surrounding ambient air into the enclosure to cool the electronics. Filter fans typically move air at a rate of 40 CFM (65M³/HR) to 375 CFM (635M³/HR). In addition to a filter that keeps dirty air from entering the electrical cabinet, filter fans also pressurize the enclosure so that dirty air is not sucked in. This is accomplished by pulling air into the enclosure at a higher rate than the rate it is allowed to exhaust out of the cabinet.

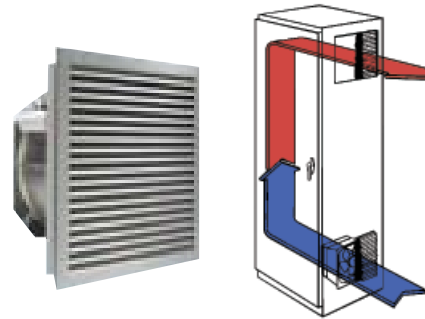

***Why You Need to Know This** – If the surrounding ambient air is not too dirty or caustic and the electronics can tolerate some heat, filter fans are a simple and inexpensive way to cool electrical enclosures.*

Full Exterior Mounting (also called Surface Mount) – An electronics cooling application in which the air conditioner or heat exchanger is completely mounted to the exterior of the electrical cabinet.

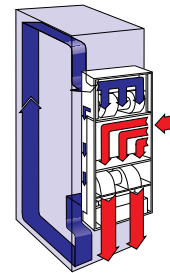

This is a popular mounting option worldwide because often there is little additional space inside the electrical enclosure to recess the air conditioner or heat exchanger, giving the entire system a more integrated appearance.

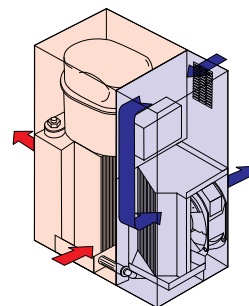

Why You Need to Know This – Understanding how the air conditioner or heat exchanger will be mounted to the electrical enclosure is essential to its specification and order placement with the manufacturer.

Fully Recessed Mounting – An electronics cooling application in which the air conditioner or heat exchanger is completely mounted on the inside of the electrical cabinet.

Some applications require the cooling solution to be fully recessed because of local codes or footprint fees, particularly in Europe. Additionally, rather than be 100% flush with the face of the electrical enclosure, the air conditioner or heat exchanger may extend beyond the face of the electrical enclosure a bit by approximately 2 inches or 50 mm. (See “Partially Recessed Mounting” as another installation application).

Why You Need to Know This – Understanding how the air conditioner or heat exchanger will be mounted to the electrical enclosure is essential to its specification and order placement with the manufacturer.

Gland Plate – When replacing an old air conditioner or heat exchanger on an existing electrical enclosure, the cut-out pattern of the new cooling product may not match the cut-out pattern in the cabinet. Thus, the old cut-out pattern is removed from the existing enclosure, and a “gland plate” with the new cut-out pattern is installed to fill the cabinet hole that was created. The new air conditioner or heat exchanger is then hung on the gland plate with the aligned cut-out patterns.

Why You Need to Know This – On occasion, engineers and other specifiers may encounter electronics cooling applications in which a gland plate will be required. Gland plates are typically sold by the electrical enclosure manufacturer and not the electronics cooling supplier. (See “Plenum” for adaptive cut-out solutions from electronics cooling manufacturers).

Hazardous Duty / Hazardous Location – A general term for any extreme situation that an air conditioner or heat exchanger may encounter such as wind-driven rain, high-pressure water from a wash-down hose, corrosive air found at a water treatment facility, salt-air at or near the ocean, and a potentially explosive environment at a petroleum facility. Air conditioners or heat exchangers used in hazardous locations need to be specially built and agency-approved to withstand these potentially harmful applications. Certifications such as UL TYPE 4, TYPE 4X, IP 56, TELCORDIA GR487 and C1D1/D2 are all ratings which relate to hazardous duty. (See the respective definitions for further explanation).

Why You Need to Know This – Engineers designing and building electrical enclosures and cooling systems may encounter hazardous duty applications and will thus need to pick the right agency-approved air conditioner or heat exchanger developed to withstand the above extreme environments.

Heat Exchanger – Heat exchangers are used for electronics cooling when engineers need to accomplish the following with their enclosure or cabinet system:

1. The sensitive electronics inside the cabinet needs to be isolated and sealed away from conditions outside the enclosure such as dirty, dusty, corrosive air or wind-driven rain (known as “closed loop” cooling).
2. The maximum temperature of the electronics may be 10° F (18° C) or more above the maximum potential air temperature outside the cabinet.

The advantages of heat exchangers include closed loop protection, lower capital cost, less electricity consumption, fewer moving components and lighter weight.

How Heat Exchangers Work – Successful heat exchanger performance depends on having cool-to-moderate ambient temperatures outside of the electrical enclosure and low-to-moderate heat energy emanating from the electronics inside the cabinet.

Electronics cooling heat exchangers have 2 basic systems at work within them. The first is the core, a heat exchanger’s central component. The core is comprised of long, thin aluminum sheeting that is folded and assembled into an accordion shape. The heat generated inside the electronics cabinet transfers across the metal core to the cooler exterior side of the enclosure. The enclosure-side and ambient-side blowers are second system in the heat exchanger. The enclosure-side blower circulates the hot electronics air through the heat exchanger to set it up to be transferred across the core. The ambient-side blower moves the cooler exterior air through the other side of the heat exchanger core to whisk the heat energy away. (See side-view diagram below).

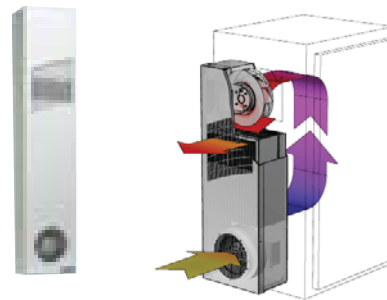

The process of how a heat exchanger works as described above is for an “air-to-air” heat exchanger. Heat exchangers can also be designed as water-to-air, air-to-water and water-to-water systems in which chilled water or a liquid such as water/glycol is circulated through the enclosure and/or ambient side to remove the heat energy from the enclosure.

Heat exchanger cooling capacities are expressed differently than air conditioners in terms of watts/°F (or watts/°K). Small capacity heat exchangers remove as little as 4 watts/°F (7 watts/°K). Large capacity heat exchangers remove as much as 84 watts/°F (151 watts/°K).

To calculate the cooling capacity of a heat exchanger, assume the application is as follows: (a) the maximum surrounding ambient temperature is 95°F, (b) the electronics is able to operate up to 105°F, and (c) 350 watts of heat needs to be removed from the enclosure. The cooling capacity of the heat exchanger would then need to be 35 watts/°F (63 watts/°K). In this example, cooling capacity is derived accordingly:

Maximum enclosure temperature	105°F (40.5°C)
Maximum ambient temperature	<u>95°F (35°C)</u>
Delta-T	10°F (5.5°C)
Watts of heat to be removed	<u>350 W</u>
Heat exchanger cooling capacity	35 Watts/°F (64 Watts/°C)

Why You Need to Know This – Understanding the proper application of a heat exchanger and gathering vital information such as maximum ambient and enclosure temperature as well as heat load are critical to determining an effective cooling solution. Your electronics cooling manufacturer can also guide you through this process.

Heat Load / Internal Heat Load – The amount of heat energy produced by the electronics inside the enclosure. The heat load comes from the unused electricity running through the components due to inefficiencies, resistance, etc. For example, if an electronics system is consuming 1,000 watts of power, and the system is 14% efficient, then the system is using only 140 watts to actually perform the functions of the electronic equipment. The other 860 watts is cast off from the electronics system in the form of heat energy. Thus, 1 watt of wasted power becomes 1 watt of heat load in the cabinet that needs to be cooled.

Why You Need to Know This – Calculating heat load is essential to determining the type and capacity of the cooling solution required for the electronics system.

Heat Transfer – The process of heat energy moving from one place to another. Heat transfer can only occur in one direction—from hot to cold. For example, a cold object put into hot water does not decrease in temperature; the object can only increase in temperature. Heat transfer is a principle at work in any electronics cooling system, moving the heat energy away from the electrical enclosure or components, so that it doesn't damage the electronics itself.

Why You Need to Know This – Heat transfer is a basic concept in electronics cooling engineering.

Hot Aisle / Cold Aisle – A term from data network room cooling. Hot aisles and cold aisles are formed by positioning data networking cabinets side-by-side in a row. The cool room air supplied by air conditioning ducts in the floor is pulled into the front of the data networking cabinets (the cold aisle), circulated through the data networking cabinets, then exhausted out the back of the cabinets (the hot aisle). Keeping the cooling air and exhausted hot air separated in a data networking environment results in a more efficient in-room cooling system and enables higher densities of computing power to be concentrated in the data networking room.

Why You Need to Know This – In designing cooling solutions for in-cabinet data networking applications, it is important to take into consideration the hot aisle / cold aisle concept, so that it is used to the engineer's advantage and doesn't negatively affect the cooling dynamics occurring within the data center room.

Impeller – Impellers are a type of air mover often used in air-cooling systems which have medium to high static pressures. Small impellers move as little as 23 CFM (cubic feet per minute) or 39 M³/HR (cubic meter per hour) of air. Larger impellers can move as much as 1,100 CFM or 1,870 M³/HR.

Impellers are available to run off of AC or DC voltage power supplies. AC volt impellers operate full-on and full-off. DC volt impellers are variable-speed capable, so that they spin in conjunction with the temperature level in the cabinet, and thus conserve power consumption.

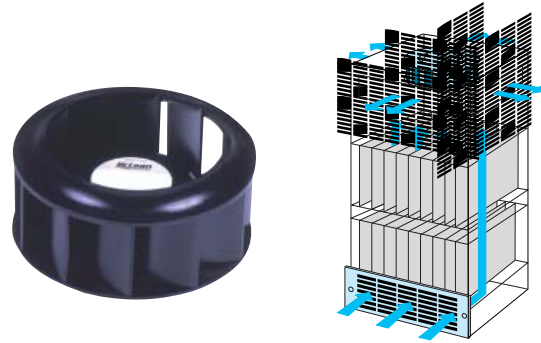

Why You Need to Know This – When specifying an impeller for fresh-air (open-loop) cooling or replacing an impeller in an electronics enclosure such as a data networking cabinet, it is especially important to know the amount of air movement required—CFM or M³/HR—and type of power supply—DC or AC.

IP Rating – IP stands for “Ingress Protection” rating which was developed by the European Committee for Electro Technical Standardization to provide consistent specifications for the level of environmental protection of electrical and electronic enclosures. Electronics cooling products such as air conditioners and heat exchangers, if destined for Europe, must also follow the IP rating definition established in the specification.

The IP rating typically consists of two numbers. The first is for protection from solid substances. The second represents protection from liquids such as water. Occasionally, a third number is used for protection against physical impact. Here are the tables which specify each IP level of protection:

**First IP Number:
Protection Against Solid Objects**

0	No special protection
1	Protected against solid objects up to 50mm (accidental touch by hands)
2	Protected against solid objects up to 12mm (fingers)
3	Protected against solid objects over 2.5mm (tools and wires)
4	Protected against solid objects over 1mm (tools, wire, and small wires)
5	Protected against dust limited ingress (no harmful deposit)
6	Totally protected against dust

**Second IP Number:
Protection Against Liquids (Water)**

0	No protection.
1	Protection against vertically falling drops of water
2	Protection against direct sprays of water up to 15° from vertical
3	Protected against direct sprays of water up to 60° from vertical
4	Protection against water sprayed from all directions, limited ingress permitted
5	Protected against low pressure jets of water from all directions, limited ingress permitted
6	Protected against low pressure jets of water, limited ingress permitted
7	Protected against the effect of immersion between 15cm and 1m
8	Protected against long periods of immersion under pressure

In electronics cooling, typical IP ratings required of an air conditioner or heat exchanger destined for Europe include IP54 or IP56 protection level. However, be sure to verify the level of Ingress Protection required for your specific electrical system and cooling solution. Other regions of the world may also use the IP system.

Why You Need to Know This – In designing an electronics system and cooling solution bound for Europe and other parts of the globe, it is important to determine the IP rating required for the application. Then select a manufacturer who is familiar and compliant with the IP rating system.

M³/HR (Cubic Meter per Hour) – The rate of air flow through a delivery system or space. M³/HR is part of the Metric system of measurement. Under the English system, air flow rates are expressed as CFM (cubic feet per minute). Air movers such as fans, blowers and impellers are rated at different levels of M³/HR or CFM ability. To convert from M³/HR to CFM, multiply M³/HR by .589.

Why You Need to Know This – In working with air movers, it is important to know if M³/HR or CFM is being used because the specifications are completely different.

NEMA / NEMA Rating – NEMA is the National Electrical Manufacturers Association, located in the United States. The organization provides consistent specifications for the type of environmental protection of electrical and electronic enclosures. For more details, visit the web site www.nema.org.

Why You Need to Know This – In designing an electronics system and cooling solution the United States, you may need to determine the NEMA electrical protection rating required for the application.

Open-Loop Cooling – Refers to the type of electronics heat management which blows cool, relatively clean ambient air from outside the enclosure through the electrical cabinet. Instead of an air conditioner or heat exchanger, fans, blowers or impellers are used to move the air through the electronics to sweep the heat away.

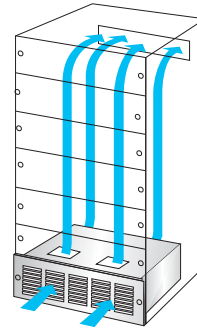

The advantages of open-loop cooling are (1) low cost vs. air conditioners and heat exchangers, (2) low cost of operation, (3) low space consumption in the electrical cabinet, (4) few moving parts and (5) common replacement product availability. Thus, if the closed-loop protection or extra cooling capability of an air conditioner or heat exchanger is not needed, open-loop cooling offers many benefits.

In selecting an open-loop air mover for electronics cooling, a number of factors need to be determined:

- Maximum ambient temperature
- Maximum enclosure temperature
- Maximum rise in temperature (ΔT)
- Heat to be dissipated (heat load)
- Hot spots in the cabinet
- Air mover type (fan tray, blower, etc.)
- Air flow (CFM or M³/HR)
- Enclosure system air resistance
- Static pressure (air flow drive)
- Negative or positive cabinet pressure
- Air filtration
- Maximum sound levels (dB)
- Power source (AC or DC)
- Voltage range (of power source)
- Optional controls & alarms
- Power consumption
- Reliability (estimated life)
- Budget

Why You Need to Know This – When considering an open-loop cooling solution, one needs to be conscious of the environment where the electrical enclosure will be installed. If there's any possibility of the ambient air damaging vital electronics through contaminants and/or high temperatures, a closed-loop cooling solution such as an air conditioner or heat exchanger should be used. If the surrounding ambient air is cool, relatively clean and heat loads are not significant, than open-loop cooling can be an effective and affordable solution. See the manufacturer's catalog and web site to learn more on how to select the proper open-loop cooling solution or contact the manufacturer.

Partial Recessed Mounting – An electronics cooling application in which the air conditioner or heat exchanger is mounted partially inside and outside of the electrical cabinet.

Partial recessed mounting creates a cleaner look and reduces the possibility of people or equipment contacting the air conditioner. However, it obviously consumes some space inside the electrical enclosure.

Why You Need to Know This – *Understanding how the air conditioner or heat exchanger will be mounted to the electrical enclosure is essential to its specification and order placement with the manufacturer.*

Plenum - Space that is used for channeling air. A plenum can be the space under the floor in data centers that distributes cool air to the “cold aisle” between the rows of network servers. It can also be an adaptor box between the enclosure and the air conditioner when the cut-out patterns do not match. One side of the plenum matches the cut-outs on the enclosure; the other side matches the cut-outs on the air conditioner; the air circulates through the plenum.

Why You Need to Know This – *Plenums can be a solution in a retro-fit application when the cut-outs of the electrical cabinet and air conditioner or heat exchanger do not match.*

Rack Mounting - An electronics cooling application in which the air conditioner is mounted inside of the electrical cabinet.

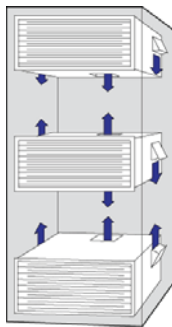

Datacom cabinets have standardized “rack” dimensions. The width of the rack equipment must be 19 inches (482.6 mm). The height is measured in “U”. Each “U” is 1.5 inches (38.1 mm) high. Thus, a rack mounted air conditioner must be 19 inches wide, and the height must be in U’s such as 7 U’s (10.5 inches).

In addition to rack mounting, side and top mounting are other options. See their definitions for more details.

Why You Need to Know This – *Data com has a specific vernacular of terms. In specifying a cooling solution within the system, it is important to know key words such as rack mounting.*

RAL Colors - A standardized color system in Germany during 1927 for the consistent application of colors because the human eye can recognize about 10 million color shades! The RAL system helps ensure that we are communicating consistent expectations for the color. A popular RAL color used in the electrical enclosure industry, for example, is RAL 7035 gray.

Why You Need to Know This – *When specifying electronics cooling products, it is important to determine the standard color of the product supplied by the manufacturer or, if desired, request that it matches the color of the electrical cabinet. The RAL color system is an easy way to communicate color expectations because it employs a standardized set of numbers which many electrical enclosure and cooling manufacturers use.*

RFI (Radio Frequency Interference) – Unintended frequencies accidentally produced by electrical products, interfering with the normal transmission and reception of broadcast equipment. An old example of RFI is the running of a hair dryer interfering with a broadcast TV’s reception.

Why You Need to Know This – *Air conditioners, heat exchangers and air movers can inadvertently produce RFI which can affect the operation of the radio equipment used in cell tower base stations. If this is the case, RFI protection must be created in the system such as on the air conditioner itself.*

Refrigerant – Refrigerant is a compound used in the cooling system of an air conditioner and other cooling products. It circulates between the enclosure-side evaporator coil and exterior-side condenser coil, carrying the heat energy from away from the electrical enclosure to cool it.

The compressor in the air conditioner is the pump that pressurizes and circulates the refrigerant between the evaporator and ambient coils. When the refrigerant is circulated toward the evaporator coil, it is pressurized into a gas to pick up the heat energy. As it circulates toward the condenser coil, it returns to liquid form, dumping the heat energy through the condenser coil. This process constantly repeats itself as the air conditioner is cooling.

Today’s air conditioners use fluorinated hydrocarbons as refrigerants, commonly referred to as R-22, their ASHAE designation. However, increasing concerns of ozone depletion are driving new legislation toward requiring the use of even more environmentally friendly refrigerants such as R-134a and R410a.

Why You Need to Know This – *In specifying air conditioners for electronics cooling, it is important to be aware of the refrigerant type required or about to be required in your part of the world, and pick a manufacturer who can help you meet your refrigerant requirements.*

RoHS / RoHS Compliant – RoHS is a law adopted by the European Union in February 2003 and took effect on July 1, 2006. The law is titled, “The Directive on the Restriction of the Use of Certain Hazardous Substances in Electrical and Electronic Equipment 2002/95/EC.” Most people commonly refer to it as RoHS or the Restriction of Hazardous Substances. Many interpret the law as a lead-free directive. However, RoHS actually restricts the use of 6 materials in electrical and electronic equipment, including air conditioners and heat exchangers. The 6 substances are as follows:

- Lead
- Hexavalent Chromium
- Mercury
- Polybrominated Biphenyls (PBB)
- Cadmium
- Polybrominated Diphenyl Ether (PBDE)

The reason for the RoHS legislation is to address the problem of toxic waste entering the environment through the disposal of out-dated electrical and electronic equipment. RoHS was enacted in close conjunction with the Waste Electrical and Electronic Equipment Directive 2002/96/EC (WEEE) which establishes collection, recycling and recovery targets for electrical and electronics products.

To determine if an electronics cooling manufacturer is RoHS compliant, their product literature and web site will often make the claim of RoHS compliancy. To verify compliancy, one may request a RoHS Certificate from the supplier. For more details about RoHS and WEEE, visit the website www.rohsguide.com.

Why You Need to Know This – In specifying an electronics cooling solution that will be sold in European Union countries, the products must be RoHS compliant by law. It is also good environmental practice to pick a RoHS compliant manufacturer if the air conditioner or heat exchanger will be used in other parts of the world.

Set Point – In electronics cooling, it is the thermostat setting on the air conditioner that creates the desired temperature in the electrical enclosure. The set point includes the coolest temperature desired, typically 75°F / 24°C, and the differential setting which is usually 10°F / 6°C higher. Thus, the temperature inside the cabinet is allowed to increase to 85°F / 29°C before the air conditioner begins to run to reduce the temperature back to 75°F / 24°C. At this point, the air conditioner turns off until the cabinet temperature increases again to the differential set point of 85°F / 29°C.

Why You Need to Know This – Determining the set point of the air conditioner ensures that the desired temperature inside the electrical enclosure is achieved.

Solar Heat Gain / Solar Load – It is extra heat created in an outdoor electrical enclosure beyond the electronics itself due to the sun baking down on the cabinet. Naturally, electronics enclosures located in direct sunlight, particularly in latitudes closer to the equator, will have more solar heat gain than cabinets further away from the equator.

Why You Need to Know This – Solar heat gain must be considered when determining the total heat load and cooling solution of an outdoor electronics system. Solar load can be reduced if the equipment cabinet is (a) not in direct sunlight, (b) painted a light color and/or (c) designed with insulation. Once these steps are taken, and there is still solar load, then extra cooling capacity will need to be added to the air conditioner, heat exchanger or air mover solution.

Static Pressure – In electronics cooling applications, it is the amount of air pressure produced by a fan, blower or impeller. Static pressure is typically measured in terms of the pressure required to raise water X inches in a tube. Fans have low static pressure; blowers have high static pressure ability; impellers deliver moderate static pressure.

Static pressure should not be confused with air flow which is the rate of air moving through a system, expressed as CFM (cubic feet per minute) or M³/HR (cubic meters per hour), not the pressure behind the air flow.

Why You Need to Know This – Electrical enclosures packed with a lot of electronics equipment usually create high resistance to air flow because the air has to travel through small spaces and at angles. Thus, an air mover with moderate-to-high static pressure such as an impeller or blower is required to help “force” the air through the electronics cabinet. Conversely, if there is free unimpeded air flow through the enclosure, then perhaps a simple axial fan or fans can cool the electronics.

Telcordia GR487 – Defines the protection requirements of electronics enclosures used in outdoor telecom applications such as wind-driven rain, dust protection, fire resistance, firearms resistance, temperature cycling, salt fog resistance, sound level and protection from transportation vibration. For more information, visit the web site www.telcordia.com

Why You Need to Know This – Electronics cooling solutions used on outdoor telecom systems need to comply with many of the key Telcordia GR487 requirements above. Thus, when specifying an air conditioner or heat exchanger for outdoor telecom use, the product must be able to meet these important requirements.

Thermal Management / Thermal Management System – Heat is the “silent killer” of electronics. Thermal management is the way to control damaging heat within an electrical enclosure, transferring it away from the cabinet where it can do no harm. Thermal management solutions used in electronics cooling include air conditioner, heat exchangers, fans and blowers.

Why You Need to Know This – Thermal management is a synonymous term for electronics cooling.

Thermostat – In electronics cooling, it is the device that monitors and controls the cooling level of an air conditioner, for example, to achieve the desired temperature inside the electronics cabinet.

Why You Need to Know This – Thermostat is a common term and device in the electronics cooling industry.

Ton – An aggregated unit of measure of cooling capacity. One ton = 12,000 BTUs (3,515 watts) per hour. The word “ton” as a unit of cooling capacity got its name from the amount of heat required to melt 2,000 pounds (a ton) of ice in one hour. Though an old term, tons are used still used today to describe the cooling ability of large capacity air conditioners in outdoor applications such as 1 ton, 3 ton, 5 ton, etc.

Why You Need to Know This – In developing large capacity air conditioning solutions for the outdoor telecom industry, as an example, one may come across the term “ton” and must be familiar with its meaning.

Top Mounting - An electronics cooling application in which the air conditioner is mounted on top of the electrical cabinet.

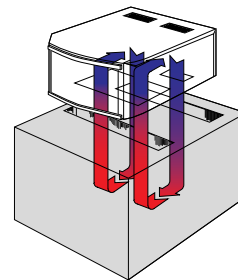

Why You Need to Know This – Occasionally, electronics cooling solutions such as an air conditioner needs to be mounted on top of the electrical enclosure possibly due to footprint space constraints around the cabinet. Top mounting provides the engineer with space management flexibility. When top mounting an air conditioner, careful consideration needs to be given to condensation management, so that the water does not run down into the electronics below, damaging it and creating a potential shock hazard.

U – A standard unit of height within a data networking cabinet. 1 U = 1.75 inches (44.5 mm). Thus, a data networking component that is 5 U's tall = 8.75 inches (222.3 mm).

Why You Need to Know This – Integrating cooling solutions into the rack system of a data networking cabinet, it is important to choose an air conditioner for example that is even-U's tall such as 6 or 7 U's.

UL / UL Approved – “UL” is the abbreviation for Underwriters Laboratories, Inc., the leading third-party product safety organization in the United States. UL has been providing product safety verification for more than 100 years. It is one of the world's most familiar safety certification symbols. Canada and the U.S. work closely together; that is why there is a “C” in the symbol. Here is a simple table which defines each type of UL protection:



UL Enclosure Types

Type	Application	Form of Protection
Type 1	Indoor	Electrical safety
3	Indoor or Outdoor	Rain, dust
3R	Indoor or Outdoor	Falling rain
3RX	Outdoor	Falling rain, corrosion
4	Indoor or Outdoor	Hose-directed water
4X	Indoor or Outdoor	Hose-directed water, corrosion
6	Indoor or Outdoor	Temporary limited-depth submersion
9	Indoor	Combustible dust
12	Indoor	Dust, dripping water, condensation
12K	Indoor	Dust, dripping water, condensation, with knock-outs
13	Indoor	Dust, fibers, water, oil

Common levels of protection for electronics cooling air conditioners and heat exchangers include NEMA Type 3R, Type 4, Type 4X and Type 12.

Why You Need to Know This – In specifying electronics cooling solutions for use in the United States, it is important to choose an air conditioner, heat exchanger, fan, blower or impeller that is UL-approved.

Volts / Voltage – The pressure under which electricity flow. Voltage is calculated as follows

$$\text{Voltage (Pressure)} = \frac{\text{Watts (Power)}}{\text{Amps (Current)}}$$

Why You Need to Know This – When specifying an air conditioner, heat exchanger or air mover, it is important to determine the voltage of the electrical supply, so that the proper cooling product can be specified to work with it.

Vortex Cooler – A unique device that uses compressed air to cool an electrical enclosure. Vortex coolers work by causing the compressed air to rotate at super-fast speeds reaching 1,000,000 rpm. As the air travels up, then down the vortex tube, the heat energy is transferred to the slower moving air out the exhaust ports. The cooled air flows through the cold air exhaust port and into the cabinet.

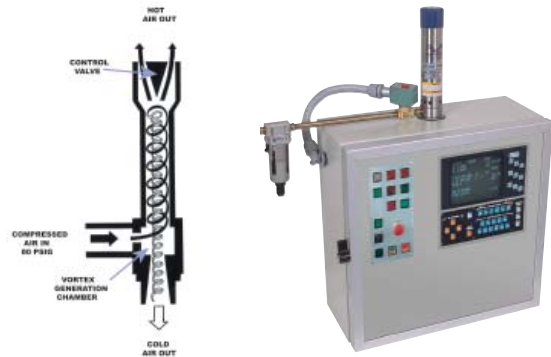

Advantages of vortex coolers include: (a) compact size, (b) work in high ambient temperatures, (c) environmentally friendly, using no refrigerants, (d) energy efficient, and (e) reliable with no moving parts that can break. However, compressed air must be available in order for vortex coolers to be used as an electronics cooling solution. Vortex coolers typically provide 400 – 2,500 BTUs (117 – 773 watts) per hour of cooling capacity.

Why You Need to Know This – In engineering a solution for an industrial process control system that needs small cooling capacity, vortex cooling maybe an option to consider.

Watt - A unit of measurement for electricity and heat. One watt of electricity that goes unused in an electrical system due to inefficiencies becomes one watt of heat energy that the electronics cooling solution needs to remove. Watts of electricity is calculated as follows:

$$\text{Watts (Power)} = \text{Voltage (Pressure)} \times \text{Amps (Current)}$$

To convert watts of heat to BTUs of heat, multiply the watts by 3.413. For example, 1,000 watts of heat = 3,413 BTUs per hour.

Heat removal in data centers, for example, is becoming an increasing challenge because the wattage used by the IT equipment such as servers, the lighting, etc. continues to grow and must be removed from the data networking room.

Why You Need to Know This – Understanding that watts of electricity often means watts of heat energy that needs to be removed from the electrical enclosure is essential to developing an electronics cooling solution with the proper amount of cooling capacity.

Wash-down Environment – An environment such as a food processing facility in which hoses are used to wash down the equipment to keep it clean and sanitary. The cooling solution used in these environments such as an air conditioner or heat exchanger, need to protect against water infiltration coming from the pressurized hose water.

Why You Need to Know This – Air conditioners or heat exchangers used to cool electronically controlled process equipment in a wash-down environment will need extra protection against hose-driven water.